

FEBRUARY 2000

BLACK BOX[®] ServSwitch[™]

USB and USB *plus*

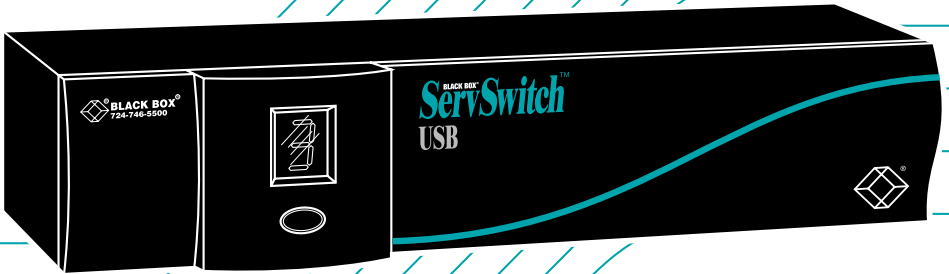

KV812A
KV814A
KV822A
KV824A

Welcome to the ServSwitch™ Family!

Thank you for purchasing a BLACK BOX® ServSwitch™ Brand KVM switch! We appreciate your business, and we think you'll appreciate the many ways that your new ServSwitch keyboard/video/mouse switch will save you money, time, and effort.

That's because our ServSwitch family is all about breaking away from the traditional, expensive model of computer management. You know, the one-size-fits-all-even-if-it-doesn't model that says, "One computer gets one user station, no more, no less." Why not a single user station (monitor, keyboard, and mouse) for multiple computers—even computers of different platforms? Why not a pair of user stations, each of which can control multiple computers? Why not multiple user stations for the same computer?

With our ServSwitch products, there's no reason why not. We carry a broad line of robust solutions for all these applications. Do you have just two PCs, and need an economical alternative to keeping two monitors, keyboards, and mice on your desk? Or do you need to share dozens of computers, including a mix of IBM® PC, RS/6000®, Apple® Macintosh®, Sun Microsystems®, and SGI® compatibles among multiple users with different access levels? Does your switch have to sit solidly on a worktable and use regular everyday cables? Or does it have to be mounted in an equipment rack and use convenient many-to-one cables? No matter how large or small your setup is, no matter how simple or how complex, we're confident we have a ServSwitch system that's just right for you.

The ServSwitch™ family from Black Box—the one-stop answer for all your KVM-switching needs!

*

This manual will tell you all about your new ServSwitch™ USB or ServSwitch™ USB Plus unit, including how to install, operate, and troubleshoot it. For an introduction to the ServSwitch USB or USB Plus, see **Chapter 2**. The ServSwitch USB and USB Plus product codes covered in this manual are:

KV812A
KV814A
KV822A
KV824A

This manual also includes information about the Remote-Control Module accessory, whose product code is:

KV6REM

TRADEMARKS USED IN THIS MANUAL

BLACK BOX and the  logo are registered trademarks, and ServSwitch, ServSwitch USB, and ServSwitch USB Plus are trademarks, of Black Box Corporation.

Apple, Mac, and Macintosh are registered trademarks, and G3 and G4 are trademarks, of Apple Computer, Inc.

Compaq is a registered trademark of Compaq Computer Corporation.

Gateway is a trademark of Gateway, Inc.

Hewlett-Packard and HP-UX are registered trademarks of Hewlett-Packard.

Zip is a registered trademark of Iomega Corporation.

IBM, PC/AT, PS/2, and RS/6000 are registered trademarks of International Business Machines Corporation.

Kensington is a registered trademark of Kensington Microware Limited.

Genius and Netmouse are registered trademarks of KYE Systems Corp.

Logitech and MouseMan are registered trademarks, and Pilot Mouse is a trademark, of Logitech, Inc.

Microsoft and Windows are registered trademarks, and IntelliMouse is a trademark, of Microsoft Corporation.

Novell and NetWare are registered trademarks of Novell, Inc.

SCO is a registered trademark of Santa Cruz Operation, Inc.

SGI is a registered trademark of Silicon Graphics, Inc.

Sun and Sun Microsystems are registered trademarks of Sun Microsystems, Inc. in the United States and other countries.

UNIX is a registered trademark of Unix System Laboratories.

Velcro is a registered trademark of Velcro USA Inc.

Any other trademarks mentioned in this manual are acknowledged to be the property of the trademark owners.

**FEDERAL COMMUNICATIONS COMMISSION AND INDUSTRY CANADA
RADIO-FREQUENCY INTERFERENCE STATEMENTS**

This equipment generates, uses, and can radiate radio frequency energy and if not installed and used properly, that is, in strict accordance with the manufacturer's instructions, may cause interference to radio communication. It has been tested and found to comply with the limits for a Class A computing device in accordance with the specifications in Subpart B of Part 15 of FCC rules, which are designed to provide reasonable protection against such interference when the equipment is operated in a commercial environment. Operation of this equipment in a residential area is likely to cause interference, in which case the user at his own expense will be required to take whatever measures may be necessary to correct the interference.

Changes or modifications not expressly approved by the party responsible for compliance could void the user's authority to operate the equipment.

This digital apparatus does not exceed the Class A limits for radio noise emission from digital apparatus set out in the Radio Interference Regulation of Industry Canada.

Le présent appareil numérique n'émet pas de bruits radioélectriques dépassant les limites applicables aux appareils numériques de la classe A prescrites dans le Règlement sur le brouillage radioélectrique publié par Industrie Canada.

DECLARATION OF CONFORMITY

This equipment has been tested and found to comply with the limits for a class B computing device in accordance with the specifications in the European standard EN55022. These limits are designed to provide reasonable protection against harmful interference. This equipment generates, uses and can radiate radio frequency energy and if not installed and used in accordance with the instructions may cause harmful interference to radio or television reception. However, there is no guarantee that harmful interference will not occur in a particular installation. If this equipment does cause interference to radio or television reception, which can be determined by turning the equipment on and off, the user is encouraged to correct the interference with one or more of the following measures:

- (a) Reorient or relocate the receiving antenna.
- (b) Increase the separation between the equipment and the receiver.
- (c) Connect the equipment to an outlet on a circuit different from that to which the receiver is connected.
- (d) Consult the supplier or an experienced radio/TV technician for help.

Shielded cables must be used with this equipment to maintain compliance with radio frequency energy emission regulations and ensure a suitably high level of immunity to electromagnetic disturbances.



NORMAS OFICIALES MEXICANAS (NOM) ELECTRICAL SAFETY STATEMENT

INSTRUCCIONES DE SEGURIDAD

1. Todas las instrucciones de seguridad y operación deberán ser leídas antes de que el aparato eléctrico sea operado.
2. Las instrucciones de seguridad y operación deberán ser guardadas para referencia futura.
3. Todas las advertencias en el aparato eléctrico y en sus instrucciones de operación deben ser respetadas.
4. Todas las instrucciones de operación y uso deben ser seguidas.
5. El aparato eléctrico no deberá ser usado cerca del agua—por ejemplo, cerca de la tina de baño, lavabo, sótano mojado o cerca de una alberca, etc.
6. El aparato eléctrico debe ser usado únicamente con carritos o pedestales que sean recomendados por el fabricante.
7. El aparato eléctrico debe ser montado a la pared o al techo sólo como sea recomendado por el fabricante.
8. Servicio—El usuario no debe intentar dar servicio al equipo eléctrico más allá a lo descrito en las instrucciones de operación. Todo otro servicio deberá ser referido a personal de servicio calificado.
9. El aparato eléctrico debe ser situado de tal manera que su posición no interfiera su uso. La colocación del aparato eléctrico sobre una cama, sofá, alfombra o superficie similar puede bloquea la ventilación, no se debe colocar en libreros o gabinetes que impidan el flujo de aire por los orificios de ventilación.
10. El equipo eléctrico deber ser situado fuera del alcance de fuentes de calor como radiadores, registros de calor, estufas u otros aparatos (incluyendo amplificadores) que producen calor.
11. El aparato eléctrico deberá ser conectado a una fuente de poder sólo del tipo descrito en el instructivo de operación, o como se indique en el aparato.

12. Precaución debe ser tomada de tal manera que la tierra física y la polarización del equipo no sea eliminada.
13. Los cables de la fuente de poder deben ser guiados de tal manera que no sean pisados ni pellizcados por objetos colocados sobre o contra ellos, poniendo particular atención a los contactos y receptáculos donde salen del aparato.
14. El equipo eléctrico debe ser limpiado únicamente de acuerdo a las recomendaciones del fabricante.
15. En caso de existir, una antena externa deberá ser localizada lejos de las líneas de energía.
16. El cable de corriente deberá ser desconectado del cuando el equipo no sea usado por un largo periodo de tiempo.
17. Cuidado debe ser tomado de tal manera que objetos líquidos no sean derramados sobre la cubierta u orificios de ventilación.
18. Servicio por personal calificado deberá ser provisto cuando:
 - A: El cable de poder o el contacto ha sido dañado; u
 - B: Objetos han caído o líquido ha sido derramado dentro del aparato; o
 - C: El aparato ha sido expuesto a la lluvia; o
 - D: El aparato parece no operar normalmente o muestra un cambio en su desempeño; o
 - E: El aparato ha sido tirado o su cubierta ha sido dañada.

Contents

Chapter	Page
1. Specifications	9
2. Introduction	11
2.1 Features and Benefits	11
2.2 The Complete Package	13
2.3 The ServSwitch USB Illustrated	14
2.4 Safety Concerns	16
3. Configuration	17
3.1 Setting the Enumeration Guard Time (Positions 5 & 6)	18
3.2 Setting the Autoscan Pause Time (Position 7)	19
3.3 Setting Which Ports to Cycle To and Autoscan (Position 8)	19
3.4 Setting the Hotkey Sequence (USB Plus with PS/2 Keyboard Only, Positions 1 & 2)	20
3.5 Enabling/Disabling Mouse Switching (USB Plus Only, Position 3) ..	20
4. Installation	21
4.1 What Else You'll Need	21
4.2 Getting Your PCs Ready and Verifying Your Peripherals	22
4.3 Connecting Your Devices	23
4.3.1 Monitor	23
4.3.2 USB Peripherals	23
4.3.3 PS/2 Keyboard and Mouse (Optional, USB Plus Only)	24
4.3.4 CPUs	26
4.3.5 Remote-Control Module (Optional, USB Plus Only)	26
4.4 Powering the System	27
5. Operation	28
5.1 Interpreting the Status Display at Power-Up	28
5.2 Using the Front-Panel Pushbutton	29
5.2.1 Channel Selection	29
5.2.2 Viewing the Firmware Revision	29
5.2.3 Autoscanning	29
5.3 Interpreting the Status Display During Normal Operation	30
5.4 Sending Commands from the PS/2 Keyboard (Optional, USB Plus Only)	31
5.5 Using the PS/2 Mouse (Optional, USB Plus Only)	32
5.6 Using the Remote-Control Module (Optional, USB Plus Only) ...	33

Contents (continued)

Chapter	Page
6. Troubleshooting	34
6.1 Things to Try	34
6.2 Calling Black Box	36
6.3 Shipping and Packaging	36

1. Specifications

Operating System

Required —

An OS with full USB-switching support, such as Windows 98 Release 2 or later or Mac OS 8.6 or later, complete with USB drivers for all your devices

Hardware

Required —

Monitor that works when directly connected to each of your CPUs (see **Section 4.1**);

Keyboard and mouse that—if they are USB type—work when directly connected to each of your CPUs

Compliance —

CE (EN55022 Class B), FCC Part 15 Subpart J Class A, IC Class/classe A

Standards —

VGA, SVGA, XGA, or XGA-2 video; supports VESA DDC1 and DDC2 monitors

Interfaces —

Video: VGA;

Keyboard and mouse: Universal Serial Bus or (USB Plus models only) IBM PS/2 compatible;

Other peripherals: Universal Serial Bus;

Option port: Proprietary

Resolution —

Up to 1600 x 1280 noninterlaced at up to 100 MHz

Video Bandwidth — 200 MHz

Maximum

Distance —

From Switch to CPUs or USB peripherals: 5 m (16.4 ft.), but this distance can be extended if USB hubs are added;

From ServSwitch USB Plus (KV822A or KV824A) to PS/2 keyboard or mouse: 30 ft. (10 m)

User Controls —

(1) Front-mounted selector pushbutton;

(1) Bottom-mounted 8-position DIP switch for configuration;

USB Plus models only:

Keyboard commands (from PS/2 keyboard only);

Mouse-click functions (from PS/2 mouse only)

Indicator —

(1) Front-mounted 7-segment status display

SERVSWITCH™ USB AND USB PLUS

Connectors —	All rear-mounted: All models: (1) HD15 female for attaching monitor; (3) USB Type A female for USB peripherals; HD15 female connectors for video from CPU: KV812A and KV822A: (2); KV814A and KV824A: (4); USB Type B female connectors for other I/O to/from CPU: KV812A and KV822A: (2); KV814A and KV824A: (4); KV822A and KV824A also have: (2) 6-pin mini-DIN female for attaching PS/2 type keyboard and mouse; (1) DB15 female for attaching Remote-Control Module
Power —	From the included power supply: Input: 100 to 240 VAC, 50 to 60 Hz, from utility-power outlet, through detachable power cord and IEC 320 male inlet, to external transformer; Output: 5 VDC at at least 2 amps from transformer to Switch; Consumption: 10 watts maximum
MTBF —	500,000 hours (based on the historical reliability of similarly designed and manufactured products)
Maximum Altitude —	10,000 ft. (3048 m)
Temperature Tolerance —	32 to 104°F (0 to 40°C)
Humidity Tolerance —	5 to 60% noncondensing
Enclosure —	Steel, aluminum, and plastic
Size —	1.8"H (1U) x 10.3"W x 5.9"D (4.5 x 26.1 x 15 cm)
Weight —	2.2 lb. (1 kg)

2. Introduction

The ServSwitch™ USB and ServSwitch™ USB Plus are high-performance peripheral-sharing devices that support computers with VGA video outputs and Universal Serial Bus (USB) peripheral ports. You can switch between two fully USB-enabled IBM® PC compatible or Apple® Macintosh® G3™ or G4™ CPUs using our 2-port Switch models (our product codes KV812A and KV822A) or four such CPUs using our 4-port models (KV814A and KV824A).

You can plug in a VGA-type monitor and as many as three USB peripherals (or more, if you add USB hubs) for these CPUs to share. Refer to **Section 4.1** to find out what types of monitors and USB peripherals are supported, as well as what cables can be used and what distances can be covered.

The ServSwitch USB Plus models (KV822A and KV824A), in addition to all of the capabilities of the regular ServSwitch USB models (KV812A and KV814A), have 6-pin mini-DIN connectors to which you can hook up an optional PS/2 keyboard and mouse. (With these, you can control the Switch with keyboard commands and mouse-click functions.) The USB Plus models also have a DB15 “option port” into which you can plug a Remote-Control Module (KV6REM, specify length of the cable component) for channel switching up to 50 ft. (15.2 m) away.

2.1 Features and Benefits

Here are some of the useful features of all of the ServSwitch USB models, as well as some of the ways those features benefit you:

- Control two to four USB-enabled CPUs, and switch their access to three or more USB peripherals, with one keyboard, monitor, and mouse.
- Units are self-powered (that is, have their own power supply), so they’re sure to provide enough power on their ports. They also have USB hub functions built-in.
- Supports VGA and related standards at resolutions up to 1600 x 1280, as well as VESA DDC1 and DDC2 video signaling.
- USB peripherals can be almost any kind of devices: keyboards, mice, joysticks, microphones, speakers, etc.
- You can switch CPU channels with the front-panel pushbutton and view the Switch’s status on the front-panel display.
- Autoscan ports for easy monitoring of CPU activity.

SERVSWITCH™ USB AND USB PLUS

- Optional CPU/Server Cables (our product code EHN810) have a VGA strand bonded to a USB strand and make connecting your CPUs a snap.

The ServSwitch USB Plus adds these exciting features:

- You can attach a PS/2 keyboard and send the Switch keystroke commands.
- You can attach a 3-button PS/2 mouse—including the Microsoft® IntelliMouse™ and compatible models—and perform mouse switching.
- Automatically restores PS/2 keyboard and mouse states when channel is changed.
- Set various autoscan and hotkey options.
- Attach optional Remote-Control Module for convenient remote switching.

2.2 The Complete Package

You should have received these components with your ServSwitch USB:

- The ServSwitch USB itself.
- Its power supply.
- This manual.

If you didn't receive everything, or if anything arrived damaged, contact Black Box right away.

The Switch's Remote-Control Module (our product code KV6REM, specify length of cable component) includes the module itself and Velcro® strips for mounting it.

2.3 The ServSwitch USB Illustrated

Status display (7-segment LED)

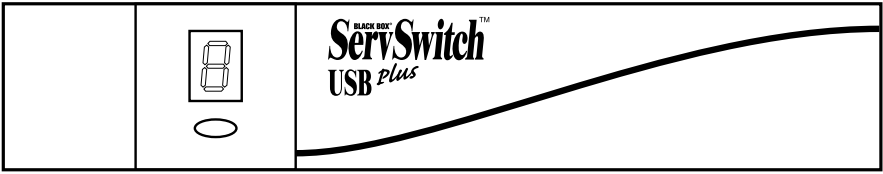

Channel-selection button
(also used to trigger firmware-version display and autoscanning; see Section 5.2)

Figure 2-1. The front panel of all ServSwitch USB models.

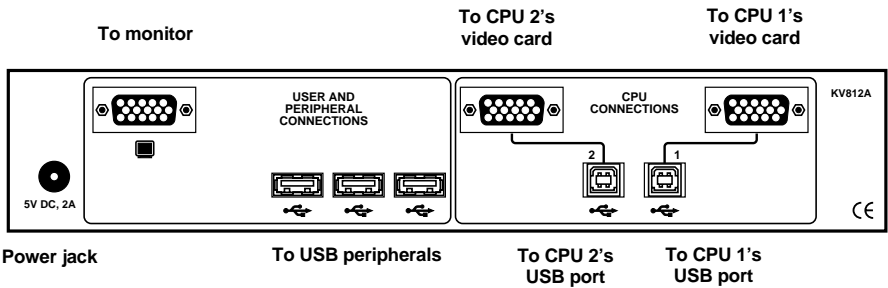

Figure 2-2. The rear panel of the 2-port ServSwitch USB (KV812A).

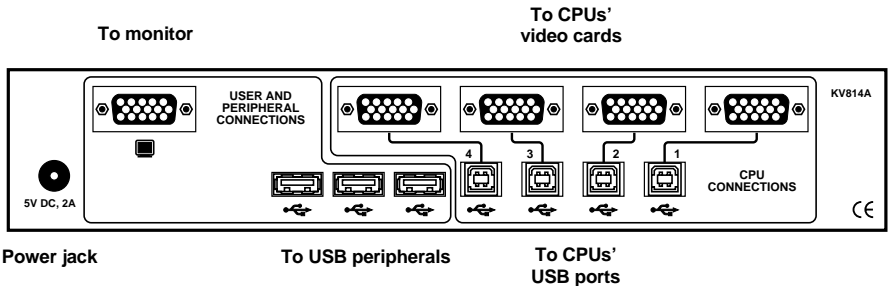

Figure 2-3. The rear panel of the 4-port ServSwitch USB (KV814A).

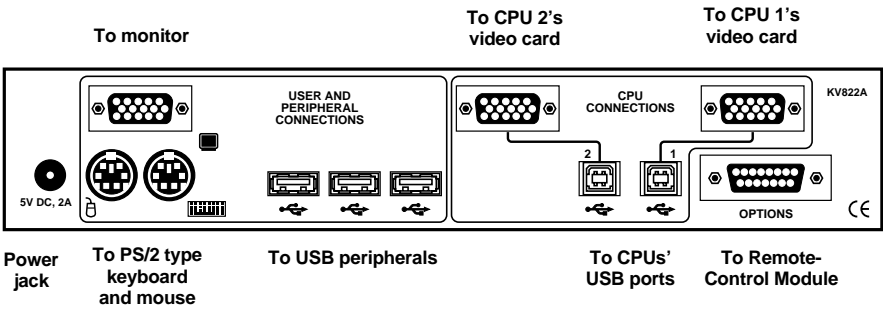

Figure 2-4. The rear panel of the 2-port ServSwitch USB Plus (KV822A).

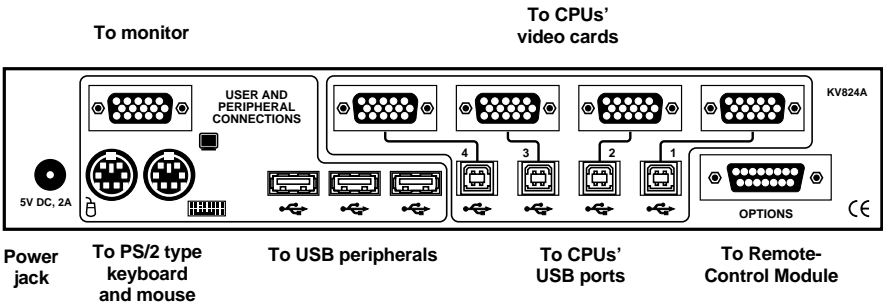

Figure 2-5. The rear panel of the 4-port ServSwitch USB Plus (KV824A).

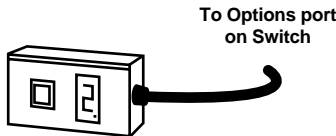

Figure 2-6. The Remote-Control Module (KV6REM, specify length of cable component), an optional accessory for the USB Plus models.

2.4 Safety Concerns

As you prepare to install the ServSwitch USB, please keep these things in mind:

- The Switch is for use in dry, oil-free indoor environments only.
- Warning: The Switch's power adapter contains *no* user-serviceable parts, but it *does* contain parts capable of delivering hazardous electric shocks—do *not* attempt to dismantle it!
- Plug the power adapter into a socket outlet close to the Switch.
- Do not use the Switch's power adapter if its case becomes damaged, cracked, or broken, or if you suspect that it is not operating properly.
- If the Switch's power adapter stops working, replace it with a manufacturer-approved adapter of the same type only.

3. Configuration

The ServSwitch USB comes from the factory preset to default configuration settings which are suitable for most applications. You can set the Switch differently by moving the positions of the configuration DIP switch on the bottom of the ServSwitch USB, shown in Figure 3-1 below, to different settings.

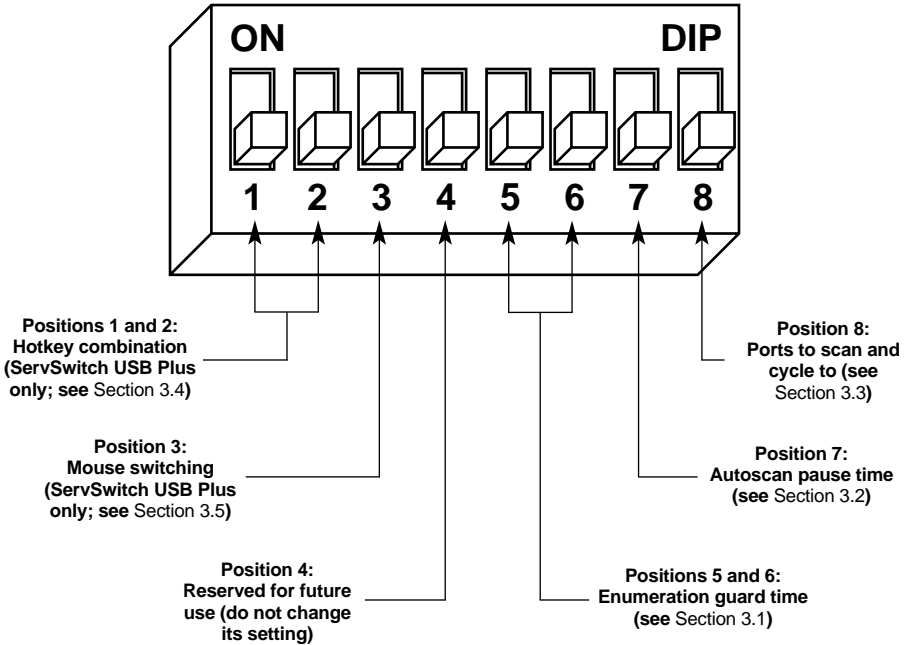

Figure 3-1. The configuration DIP switch.

3.1 Setting the Enumeration Guard Time (Positions 5 & 6)

When devices are connected to or disconnected from a USB bus, the devices on that bus then need a certain amount of time for uninterrupted communication in order for the currently selected CPU to determine the new makeup of the bus—which USB devices are connected, what capabilities those devices have, etc. This process is called “enumeration.” The USB devices attached to the ServSwitch USB begin to perform enumeration each time that a new CPU channel remains selected for more than one second.

If enumeration is interrupted before it’s complete, some or all of the devices on the bus can crash. So, starting one second after a new channel has been selected, the ServSwitch USB enforces a “guard time” during which no further switching is possible. The front-panel 7-segment display will begin blinking to show you that enumeration is underway and the guard time is in effect, and it will keep blinking faster and faster until the guard time expires.

(You can still quickly cycle through the channels for as long as you like, because there is an initial one-second window after each channel change during which the ServSwitch USB is busy resynchronizing the video and doesn’t even attempt to communicate with the computer’s USB port. Also note that enumeration is not performed during autoscanning; video from each CPU is displayed, but no USB communication occurs until you stop the scan at a particular port.)

The factory-default enumeration guard time is 2 seconds; the other possible settings are 4, 8, and 16 seconds. The bus will probably only need two seconds if you only have a USB keyboard and mouse attached to it, but as you add more peripherals (especially hubs and Zip® drives), enumeration will require more time to finish. We suggest that you time the process—wait until the CPU’s on-screen hourglass or clock stops running and all of your USB devices return to normal operation—then set the ServSwitch USB to use the shortest guard time that’s still longer than the actual enumeration time.

To set the enumeration guard time, move positions 5 and 6 of the DIP switch on the bottom of the ServSwitch USB to your desired setting:

Guard Time	Position 5	Position 6
Two seconds (default)	OFF (down)	OFF (down)
Four seconds	ON (up)	OFF (down)
Eight seconds	OFF (down)	ON (up)
Sixteen seconds	ON (up)	ON (up)

3.2 Setting the Autoscan Pause Time (Position 7)

You can set how long the ServSwitch USB will pause to display each attached CPU's video when you autoscan the CPUs (known as the "pause time" or "dwell time"; for more information on autoscanning, see **Section 5.2.3**). To do so, move position 7 of the DIP switch on the bottom of the ServSwitch USB to OFF (down) for two seconds (the factory-default setting) or to ON (up) for five seconds.

3.3 Setting Which Ports to Cycle To and Autoscan (Position 8)

When you manually cycle through CPU channels and when the ServSwitch USB autoscans (see **Section 5.2.3**), the Switch will either stop/pause at each active CPU port (the factory default) or at each and every CPU port whether it's active (or even occupied) or not. To set which ports the Switch cycles to and scans, move position 8 of the DIP switch on the bottom of the ServSwitch USB to OFF (down) to have the Switch stop at the active ports only (the factory-default setting) or to ON (up) to have the Switch stop at all ports.

Even if you set your ServSwitch USB Plus for active ports only, it will still switch to an empty CPU port if you send it a command from the PS/2 keyboard to switch directly to that particular port number.

3.4 Setting the Hotkey Sequence (USB Plus with PS/2 Keyboard Only, Positions 1 & 2)

You can access several of the ServSwitch USB Plus’s main functions (such as CPU-channel selection and autoscanning) by sending commands from a PS/2 type keyboard attached to the Switch’s PS/2 keyboard port (refer to **Section 5.4**—the Switch *cannot* recognize commands from a USB keyboard). Each command must start with a “hotkey sequence” (series of keystrokes) that alerts the Switch to interpret the keyboard data that follows it as a command.

The default hotkey sequence is [Ctrl] and [Alt] pressed simultaneously. If any of the applications on computers attached to the Switch require this sequence to trigger important application-specific functions, you will have to either send that sequence to the application from an attached USB keyboard (because the Switch will *not* recognize hotkey sequences sent from USB keyboards), or you’ll have to change the Switch’s hotkey sequence.

To change the hotkey sequence, move positions 1 and 2 of the DIP switch on the bottom of the ServSwitch USB Plus to your desired setting:

PS/2 Keyboard Hotkeys	Position 1	Position 2
[Ctrl] and [Alt] (default)	OFF (down)	OFF (down)
[Ctrl] and [Shift]	OFF (down)	ON (up)
[Alt] and [Shift]	ON (up)	OFF (down)
No hotkeys (PS/2 keyboard commands disabled)	ON (up)	ON (up)

3.5 Enabling/Disabling Mouse Switching (USB Plus Only, Position 3)

In the ServSwitch USB Plus’s factory-default state, you can use a three-button PS/2 mouse or IntelliMouse attached to the Switch’s PS/2 mouse port to cycle through the Switch’s CPU channels; see **Section 5.5**. If you don’t want to use this feature—particularly if it’s going to conflict with mouse-controlled application functions—you can disable it.

To enable mouse switching, move position 3 of the DIP switch on the bottom of the ServSwitch USB Plus to OFF (down, the factory-default setting). To disable mouse switching, move position 3 to ON (up).

4. Installation

4.1 What Else You'll Need

You'll need to have these things before you can install your ServSwitch USB:

- Cables to connect the ServSwitch USB to the video and USB ports of each of your PCs. We recommend our bonded VGA/USB cable, product code EHN810.
- A monitor with a standard VGA/SVGA (HD15) connector that will work when connected directly to each of your PCs. The ServSwitch USB supports low- and high-resolution monitors.
- A standard PC compatible keyboard. With regular ServSwitch USB models, this must be a USB keyboard; with ServSwitch USB Plus models, this can be a standard PC/AT or PS/2 style keyboard (it *must* be such a keyboard if you want to switch channels with it). (If you want to use a PC/AT keyboard with a 5-pin DIN connector, you'll need a standard PC/AT to PS/2 keyboard adapter—our product code FA212—to connect it to the ServSwitch USB Plus.)
- A standard PC compatible mouse (if you're going to use a mouse at all—the Switch can operate without a mouse connected). With regular ServSwitch USB models, this must be a USB mouse; with ServSwitch USB Plus models, this can be a PS/2 style two- or three-button Microsoft or Logitech® compatible mouse or a Microsoft IntelliMouse compatible mouse. If you want to use the PS/2 mouse to switch channels on the ServSwitch USB Plus, you will need a three-button mouse or an IntelliMouse. (The Switch supports other “Internet mice” compatible with the IntelliMouse—fitted with a wheel or other scrolling control, and sometimes additional buttons—including the Logitech MouseMan®+, Genius® NetMouse®, and Genius NetMouse Pro.)
- Suitable USB software drivers for all of your peripherals.

4.2 Getting Your PCs Ready and Verifying Your Peripherals

Before you begin installing your system, check the OS version(s) you have installed on your computers. If you're running Windows® 98 or Mac® OS, we highly recommend that you upgrade to the latest version of the operating system, because the USB handling has tended to become more reliable with each new revision. You should upgrade Windows 98 to at least Release 2, and, in particular, you *must* upgrade Mac OS to at least version 8.6; Mac CPUs with earlier OS versions tend to hang following about 50 switch cycles. Other operating systems, such as Windows 2000, HP-UX®, Linux®, SCO® UNIX®, and Novell® NetWare®, now have USB support or are expected to add it soon. However, DOS, Windows 3.x, Windows 95, and Windows NT either do not support USB or do not support it adequately.

You will probably also need to configure any IBM PC compatible computers you plan to attach so that they will accept USB peripherals. Unfortunately, at the time of this writing, most PCs can't automatically detect the presence of a USB keyboard or other USB devices without initial detection of, or input from, a regular PS/2 keyboard. Some such CPUs will require you to attach an actual PS/2 keyboard to them, because you have to do an initial operating-system configuration to make the CPU USB-aware and to make sure that the appropriate drivers are installed. But many CPUs just need to "see" a PS/2 keyboard, and then will autodetect the USB keyboard; while you boot up these CPUs, you can simply plug in a PS/2 keyboard emulator such as our Keyboard and Mouse GHOST Emulator, product code AC245A, instead of attaching a real PS/2 keyboard.

It is also probably a good idea at this point to directly attach all of the USB peripherals you plan on using to each of your CPUs, load the drivers, and make sure that the devices work correctly when they are directly plugged into the CPUs. This way, if there are problems with your equipment, cabling, or drivers, you can find them before you put your whole system together.

4.3 Connecting Your Devices

As you connect your equipment, make sure that your ServSwitch USB and (if possible) all the devices you want to attach to it are turned off and unplugged.

4.3.1 MONITOR

The shared monitor in your system must work when directly attached to any of your computers, which includes being able to display all of the types of video that they can output.

If this monitor's video cable has an HD15 male connector, you can plug it right into the ServSwitch USB's monitor port; this is the HD15 female connector labeled with the picture of a monitor in the teal-colored "USER AND PERIPHERAL CONNECTIONS" area on the rear panel of the Switch. If the monitor is truly compatible with all of your CPUs but has some other kind of connector, you will need a video adapter or converter of some kind; call Black Box for technical support.

4.3.2 USB PERIPHERALS

Use standard USB cables such as our product code USB01 to attach your USB keyboard, mouse, scanner, printer, speaker, microphone, camera, hub, or other peripherals to the ServSwitch USB's user-side USB ports. (These are the three Type A female USB connectors labeled with a triple branching icon in the teal-colored "USER AND PERIPHERAL CONNECTIONS" area on the rear panel of the Switch.) A few things you need to keep in mind as you attach these peripherals:

- **Important:** Normally, you would not be able to press the Power key on Mac USB keyboards to boot CPUs attached to the keyboards through USB switches or hubs, because they don't support the special Mac power circuit. The ServSwitch USB *does* support this circuit, but only on the *rightmost* of its three USB peripheral ports. So if you want to be able to boot an attached Mac computer from your Mac USB keyboard, you *must* plug the keyboard into that rightmost port.
- Normally, cable must not be run farther than 5 m (16.4 ft.) from the Switch to your USB peripherals. However, if you are using USB hubs, the total cable distance from the Switch through your hub(s) to the peripherals can be longer as long as the peripherals are not more than 5 m (16.4 ft.) from the hub they are attached to.
- Because the Switch provides the USB-standard 500 mA on its USB ports, you can attach one layer of nonpowered hubs to the Switch. Just remember *not* to cascade any nonpowered hubs from other nonpowered hubs; your USB bus will fail if you do.

- In applications that include both IBM compatible and Mac G3 or G4 type CPUs, a single keyboard—either PC/Mac/generic USB type or (with ServSwitch USB Plus models) PS/2 type—should suffice for most of the activities you’ll want to do on either platform. You just have to be aware of the cross-platform mappings of the keys, shown in Table 4-1 on the next page. Also, when you use a PC keyboard, the functions of the Mac keyboard’s Power key will not be available.
- You can use the left mouse button on a PC USB type or (with ServSwitch USB Plus models) PS/2 type mouse with two or three buttons to perform any Mac mouse-click function. However, you cannot use a single-button Mac mouse to perform the PC mouse-click functions that require the center or right mouse button, so we recommend that you use a PC mouse in a mixed PC/Mac system.
- We do not recommend attaching more than one USB video camera at a time to the system. Videocams make heavy demands on USB bandwidth; it can be very difficult for a single bus to properly support two or more of them simultaneously.

4.3.3 PS/2 KEYBOARD AND MOUSE (OPTIONAL, USB PLUS ONLY)

If your PS/2 keyboard has a 6-pin mini-DIN male connector, you can plug it right into the ServSwitch USB Plus’s PS/2 keyboard port; this is the 6-pin mini-DIN female connector labeled with the picture of a keyboard in the teal-colored “USER AND PERIPHERAL CONNECTIONS” area on the rear panel of the Switch. If the keyboard is a PC/AT type with a 5-pin DIN male connector, you’ll need a keyboard adapter such as our product code FA211 to make this connection. If your keyboard is really PS/2 compatible but has some other type of connector, call Black Box for technical support.

If your PS/2 mouse has a 6-pin mini-DIN male connector, you can plug it right into the ServSwitch USB Plus’s PS/2 mouse port; this is the 6-pin mini-DIN female connector labeled with the picture of a mouse in the teal-colored “USER AND PERIPHERAL CONNECTIONS” area on the rear panel of the Switch. If your mouse is really PS/2 compatible but has some other type of connector, call Black Box for technical support. The Switch does not support PC/AT type RS-232 serial mice.

The PS/2 keyboard is capable of performing most of the activities you’ll want to do on either the PC or Mac platform—you just have to be aware of the cross-platform mappings of the keys, which are shown in Table 4-1 on the next page. Also, when you use a PC keyboard, the functions of the Mac keyboard’s Power key will not be available.

Table 4-1. Keyboard Key Mappings

Generally, USB keyboards have uniform position-based codes for their keys, so any keys that occupy more or less the same positions and perform more or less the same functions across platforms will map one-to-one. However, certain keys available on certain keyboards do not correspond well or are not available on other types of keyboards, so the ServSwitch USB maps the more important of these as shown below.

<p>On the IBM PC 104/105-key keyboard, the ___ key: Left Ctrl Left Windows Start (⊞) Left Alt Right Alt or Alt Graph Right Windows Start (⊞) Right Ctrl</p>	<p>Emulates the Apple keyboard's ___ key: Left Control Left Command (⌘) Left Option (alt) Right Option (alt) Right Command (⌘) Right Control</p>
<p>On the Apple keyboard, the ___ key: Left Control Left Option (alt) Left Command (⌘) Right Command (⌘) Right Option (alt) Right Control</p>	<p>Emulates the PC 104/105-key keyboard's ___ key: Left Ctrl Left Alt Left Windows Start (⊞) Right Windows Start (⊞) Right Alt or Alt Graph Right Ctrl</p>

Things to keep in mind:

1. Do not use an older 101/102-key PS/2 keyboard with the ServSwitch USB Plus when you have any Macintosh computers attached, because 101/102-key PC keyboards cannot emulate the Command (⌘) keys on the Apple keyboard.
2. The Power (⏻) key on the Mac keyboard does not map to anything on a PC keyboard, nor does anything on a PC keyboard map to it. Similarly, the Windows Application (⊞) key on a PC keyboard does not map to anything on a Mac keyboard, nor does anything on a Mac keyboard map to it. The functions of these keys are simply not available when you use a keyboard designed for the other platform.

4.3.4 CPUs

To connect your CPUs to the ServSwitch USB, you'll need to run cable from the Switch to their USB ports and VGA video ports. You can do this in one of two ways:

- We strongly recommend that you use our special bonded two-to-two cable (our product code EHN810, specify length). It has a high-quality VGA video strand bonded to a USB strand. Attach the end of this cable with a Type A male plug and an HD15 male plug to the Type A female USB port and the HD15 female video port on your computer. Attach the other end of this cable to one of the matched numbered Type B female CPU USB ports and HD15 female CPU video ports in the gray-colored "CPU CONNECTIONS" area on the rear panel of the Switch.
- You can also use separate video-extension cables and USB cables. Run a high-quality HD15 male to HD15 male VGA video-extension cable such as our product code EVNPS05-MM (specify length) from the CPU's HD15 female video port to one of the numbered HD15 female CPU video ports in the gray-colored "CPU CONNECTIONS" area on the rear panel of the Switch. Then run a USB cable such as our product code USB01 from the CPU's Type A female USB port to the Type B female CPU USB port on the rear of the Switch that has the same number as the CPU video port you just hooked up.

Be sure to use high-grade cabling for your CPU-to-Switch video connection. Cable made to lower standards often doesn't carry video signals adequately. In particular, Macintosh video is very sensitive to the cabling environment; lesser-quality cable can cause Mac video to degrade badly.

If one of your CPUs outputs VGA or another type of video that the ServSwitch USB supports, but its video port is not an HD15 connector, please call Black Box for technical support.

4.3.5 REMOTE-CONTROL MODULE (OPTIONAL, USB PLUS ONLY)

If you'd like to be able to change the CPU channel on your ServSwitch USB Plus from farther away than normal, you can plug a Remote-Control Module (RCM for short, our product code KV6REM—specify the length of its cable component) into the DB15 female connector labeled "OPTIONS" on the rear panel of the Switch. Once you make this attachment, you can press the button on the RCM when the ServSwitch USB is operating to switch to the next CPU; the number of the currently selected CPU channel will be displayed in the RCM's 7-segment LED display.

4.4 Powering the System

Once you've installed your ServSwitch USB and attached your equipment to it, you need to apply power to the Switch system. Plug the power supply's output cord into the power jack on the back of the ServSwitch USB, then attach the input cord to the power-supply transformer's IEC 320 inlet, then plug the input cord into utility (mains) power. The Switch should start operating immediately; it has no ON/OFF switch. Now plug in and power on your monitor and any other powered peripherals. Lastly, plug in and power on your CPUs.

Always apply power to the ServSwitch USB *first, then* power on the monitor and each of the computers; if you power up the computers before the Switch, the system will probably not work. In particular, some Mac computers that power up without a monitor attached either directly or through the Switch will go into a "no video" mode and will simply not output any video signal. There is no way to correct this situation; a Mac that powers up with no video must be rebooted.

5. Operation

This chapter explains the general operation of the ServSwitch USB. We recommend that you read this chapter carefully before starting to use the Switch.

5.1 Interpreting the Status Display at Power-Up

When you plug in the ServSwitch USB to power it up, its front-panel 7-segment display will show one of three things:

- If it's not actually getting any power, the display will be blank.
- If it's getting power and its front-panel pushbutton isn't pressed, it will select CPU channel #1; the display will blink "1" while the USB "enumeration process" occurs—see **Section 3.1**—then will be solidly lit "1".
- If it's getting power and its pushbutton *is* pressed, the display will show the firmware revision (see **Section 5.2.2**), *then* blinking and solid "1" as above.

For the meaning of this display after power-up, see **Section 5.3**.)

DISPLAY SHOWS:

Blank

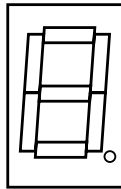

MEANING:

Switch is not receiving enough power to operate

Flashing number "1"

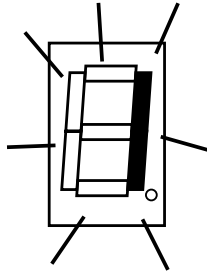

Switch has powered up normally and is performing enumeration

Alternating letter "F"s and numbers

Steadily lit number "1"

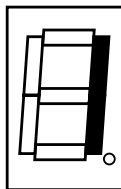

Switch is displaying its firmware revision

Switch has powered up normally and is ready to operate

Figure 5-1. The front-panel status display at power-up.

5.2 Using the Front-Panel Pushbutton

5.2.1 CHANNEL SELECTION

During normal ServSwitch USB operation, you can use the Switch's front-panel pushbutton to select which CPU channel (CPU port) you want to access and control. Press and release the key once to select the next higher-numbered CPU channel; press and release the key repeatedly to manually cycle through the channels. Bear in mind that depending on how position 8 of the Switch's DIP switch is set, the Switch will change to either (a) the next *active* channel or (b) the next channel *in sequence*, regardless of whether the channel is active or not (see **Section 3.3**). One second after you switch to a new channel, enumeration is performed (see **Section 3.1**).

5.2.2 VIEWING THE FIRMWARE REVISION

For technical-support purposes, it might be necessary to find out the firmware-release version of the control software in your ServSwitch USB. Before calling Black Box Tech Support about a problem, turn off the Switch and then turn it back on while holding down the front-panel pushbutton (hold down the button for five seconds). This will cause the Switch to briefly show the letter "F" alternating with the firmware's version number, one digit at a time, on its front-panel 7-segment display, followed by the equals sign ("="). For example, if the Switch is using firmware revision 1.02, it will display the letter "F", then the digit "1", then the letter "F" again, then the digit "0", then the letter "F" one more time, then the digit "2", and finally the "=" character. After displaying the firmware revision, the Switch will select CPU channel #1 and perform enumeration (see **Section 3.1**), and then the display will begin showing what it normally does (see **Section 5.3**).

5.2.3 AUTOSCANNING

To have the ServSwitch USB start "autoscanning," press the Switch's front-panel pushbutton and hold it down for five seconds. The Switch will disconnect the USB bus and then cycle through your CPU channels continuously. While it does this it will show a circling pattern on its front-panel display (see the next section) and will briefly show each channel's video signal (or lack of video signal) on the shared monitor. You can stop the scan at a particular port by pressing and releasing the front-panel pushbutton when the scan reaches that port. (With the ServSwitch USB Plus, you can also stop the scan by sending a command from the PS/2 keyboard [see **Section 5.4**], by clicking the PS/2 mouse to the next higher or lower port [see **Section 5.5**], or, if you have a Remote-Control Module, by pressing its SELECT button [see **Section 5.6**].) When you stop the scan, enumeration is performed (see **Section 3.1**) and then full USB access and control resumes. You can set how long the Switch pauses on each CPU channel, and whether the Switch includes empty channels, when it autoscans; see **Sections 3.2** and **3.3** respectively.

5.3 Interpreting the Status Display During Normal Operation

The ServSwitch USB's front-panel 7-segment status display usually shows the number of the currently selected computer channel. On the ServSwitch USB Plus models, the dot LED alongside it also flashes in response to data from the shared PS/2 keyboard or mouse, as shown in the top illustration in Figure 5-2 below.

When you change CPU channels, this display will flash as shown in the second illustration below, more and more quickly, until the USB "enumeration" process is complete (see **Section 3.1**); until the display stops flashing, the channel cannot be changed again.

If you hold in the Switch's front-panel pushbutton for five seconds, the Switch starts autoscanning (see **Section 5.2.3**). The display will alternately (a) show the current channel number and (b) light each of its outer six LED segments, one after the other, in a clockwise sequence, as shown in the third illustration.

DISPLAY SHOWS:

Channel number 1 through 4,
steadily lit

As above, with flashing dot in
lower right-hand corner

Zero

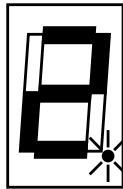

MEANING:

That channel is selected

USB Plus models only: Switch is
receiving PS/2 keyboard or
mouse data

Video is disabled, but not controls

Channel number 1 through 4,
flashing

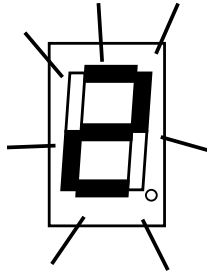

Switch is performing
enumeration

Alternately, channel number and
clockwise progression of lit
segments

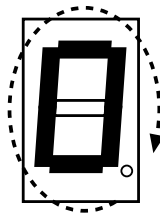

Switch is in autoscanning mode,
scanning from channel to
channel, pausing at each one
for user-selected period

Figure 5-2. The front-panel status display during regular operation.

5.4 Sending Commands from the PS/2 Keyboard (Optional, USB Plus Only)

You can control many functions on the ServSwitch USB Plus—such as CPU-channel selection, autoscanning, or disabling video—from an attached PS/2 keyboard, using commands triggered with the Switch’s currently selected hotkey combination. All of the hotkey-control commands are invoked by holding down the one or two hotkeys and then pressing a command key. By default, the two hotkeys are [Ctrl] and [Alt], although other keystroke combinations can be selected (see **Section 3.4**). (The Switch *cannot* recognize commands from USB keyboards, because hardware and software have not yet become advanced enough for a switch to be able to isolate and absorb individual keyboard characters from a USB data stream on the fly.)

Normally, when you send a hotkey command, you have to release the hotkeys and the command key before you can send another one. The one exception to this rule is {Hotkeys} + [Tab], the “switch to next CPU channel” command; you can “tab through” the channels by holding down the hotkeys and repeatedly pressing [Tab].

It is particularly easy to enter commands with extended keyboards on which additional keys can be programmed to act as combinations of other keys. PS/2-interface versions of such keyboards are supplied with many Gateway™ computers. If you program one of these “spare” keys to produce both hotkey keystrokes, or if you program a set of these keys to produce the hotkey *and* channel-number keystrokes, you’ll be able to select channels and do other things with as few as one or two keypresses.

The hotkey commands are summarized below. Note that to generate the numeric digits in the commands that contain them, you need to press the number keys on the top row of the main section of the keyboard, *not* the number keys on the keypad; the Switch will not recognize keypad numbers.

- Use {Hotkeys} + [*x*], where *x* is either one or two (on the 2-port models) or a number from one to four (on the 4-port models), to switch to the corresponding CPU channel. If you try to select a channel with a higher number than the Switch has ports, the Switch will ignore the command and pass it through to the currently selected computer.
- Use {Hotkeys} + [Tab] to switch to the next higher-numbered channel. This channel can either be the next *in sequence* or the next *active* channel, depending on how the Switch is configured (see **Section 3.3**).

- Use {Hotkeys} + [A] to have the Switch start autoscanning (briefly displaying the video from each CPU channel in turn). You can control whether or not the Switch scans empty channels and how long it pauses at each channel; see **Sections 3.3** and **3.4**. To stop autoscanning, simply select a fixed channel by pressing and releasing the Switch's front-panel pushbutton, sending a channel-selection command from the PS/2 keyboard, clicking to a higher or lower channel with the PS/2 mouse, or, if you have a Remote-Control Module, by pressing its SELECT button. For more about autoscanning, see **Section 5.2.3**.
- Use {Hotkeys} + [0] to select nonexistent "channel zero" in order to shut off the video output from the Switch to the shared monitor. The Switch's front-panel display will show "0". You can re-enable video by selecting another channel in any of the available ways.

Examples of common hotkey commands (assuming the hotkeys are [Ctrl] and [Alt]):

- *To select channel 2:*
Press and hold [Ctrl] and [Alt], press and release [2], release [Ctrl] and [Alt].
- *To "tab through" channels:*
Press and hold [Ctrl] and [Alt], press and release [Tab] (repeat as many times as necessary), release [Ctrl] and [Alt].

5.5 Using the PS/2 Mouse (Optional, USB Plus Only)

Yet another convenient way to select CPU channels on the ServSwitch USB Plus is through a three-button PS/2 type mouse, if this feature is enabled (see **Section 3.5**). Simply hold down the central mouse button or "wheel" button, then click on the left-hand mouse button to switch to the next higher-numbered channel or the right-hand button to switch to the next lower-numbered channel. Keep in mind that the "next channel" will be either the next channel in sequence or the next active channel, depending on how the Switch is configured (see **Section 3.3**).

If you disconnect the shared PS/2 mouse from the ServSwitch USB Plus by accident during operation, the mouse will not work right when you plug it back in. To avoid having to reboot the entire system in this situation, the Switch has an automatic mouse-recovery system. With the PS/2 mouse disconnected, you can trigger the recovery system by changing the channel using the Switch's front-panel pushbutton or the keyboard hotkeys. The ServSwitch USB Plus detects that the mouse has been disconnected and triggers the recovery system. Plug in the PS/2 mouse and the Switch will re-initialize it.

5.6 Using the Remote-Control Module (Optional, USB Plus Only)

An optional Remote-Control Module (“RCM” for short, our product code KV6REM, specify the length of the cable component) is also available for the ServSwitch USB Plus. It’s a small hand-held accessory—with a SELECT key that mimics the Switch’s pushbutton and an identical copy of the Switch’s front-panel display—whose cord you can plug into the Switch’s OPTIONS port. This is particularly useful in applications such as training and demonstration when you need to be able to switch CPU channels while standing or walking some distance from the Switch and its other attached user equipment. The RCM can be conveniently attached to most surfaces with the included Velcro strips so you can have channel information and channel-selection control at your fingertips.

6. Troubleshooting

6.1 Things To Try

This section suggests possible answers for a number of problems that people sometimes encounter when trying to operate the ServSwitch USB. If the suggested actions don't solve your problem, or if you don't see a listing for the type of trouble you're having, contact Black Box Technical Support as described in **Section 6.2**.

The Switch doesn't seem to work with my PCs that run DOS, Windows 3.x, Windows 95, or Windows NT.

USB support in these operating systems ranges from inadequate to nonexistent. You will need to upgrade the operating systems on those PCs. See **Section 4.2**.

The Switch doesn't accept hotkey commands from my USB keyboard.

The Switch can only accept hotkey commands from a PS/2 keyboard attached to a ServSwitch USB Plus. Unfortunately, the Switch can't recognize commands from USB keyboards. See **Section 5.4**.

My PCs don't seem to recognize my USB peripherals.

Make sure the operating-system versions they are running actually support USB properly. Even if they do, you might need to attach a regular PS/2-type keyboard or keyboard emulator before they will be able to recognize USB devices. See **Section 4.2**.

I don't get any video signal from my Mac CPUs.

When you power up your ServSwitch USB system, make sure to power up the Switch or a directly attached monitor *before* you boot your Mac CPUs. Mac CPUs that don't sense a video device when they boot up often simply turn off their video output. See **Section 4.4**.

My computers crash at odd intervals.

Make sure the operating-system versions they are running actually support USB properly (see **Section 4.2**). If they do, call Black Box Technical Support.

My computers or USB devices crash almost every time I switch between CPUs.

Make sure the operating-system versions they are running actually support USB properly (see **Section 4.2**). If they do, the enumeration guard time that your ServSwitch USB is set for is probably too short (see **Section 3.1**); see how long it takes your system to enumerate and set the guard time longer than that.

The Power key on my Mac USB keyboard doesn't seem to work.

For its Power key to function properly, a Mac USB keyboard *must* be plugged into the ServSwitch USB's *rightmost* USB-peripherals port (see **Section 4.3.2**).

I can't do any of the Mac Power-key functions with my PC USB or PS/2 keyboard.

Unfortunately true. For Power-key functions, you *must* plug a Mac USB keyboard, at least temporarily, into the ServSwitch USB's *rightmost* USB-peripherals port (see **Section 4.3.2**).

My video quality is poor (smearing, fuzziness, rippling, etc.).

Use shielded or screened coaxial video cables to connect your monitor and CPUs to the ServSwitch USB.

***ServoSwitch USB Plus only:* My PS/2 mouse doesn't move the cursor/pointer.**

Check the mouse connection to the Switch; if it's OK, try changing the CPU channel to recover the mouse (see **Section 5.5**).

***ServoSwitch USB Plus only:* My PS/2 or PC/AT type keyboard doesn't function when it's attached to the Switch, or functions only intermittently. The Num Lock LED doesn't always light when the Num Lock key is pressed.**

Some older keyboards were designed for use with specific computers and are not truly PC/AT or PS/2 compatible. These are not common, but if you're having problems like this and you're using an old keyboard, try a newer keyboard.

***ServoSwitch USB Plus only:* Just using my PS/2 mouse normally causes the Switch to change the CPU channel unexpectedly.**

Some cheaper PS/2 mice are not fully compatible with the ServSwitch USB Plus and can lose data, which—if mouse switching is enabled (see **Sections 3.5** and **5.5**)—sometimes causes the Switch to interpret a data stream as a channel-change request. Try using a Microsoft, Logitech, IBM, Compaq®, or Hewlett-Packard® mouse instead.

6.2 Calling Black Box

If you determine that your ServSwitch USB is malfunctioning, *do not attempt to alter or repair the unit*. It contains no user-serviceable parts. Contact Black Box Technical Support at 724-746-5500.

Before you do, make a record of the history of the problem. We will be able to provide more efficient and accurate assistance if you have a complete description, including:

- the nature and duration of the problem;
- when the problem occurs;
- the components involved in the problem—that is, what types of computers, what types of peripherals, make and model of monitor, etc.;
- any particular application that, when used, appears to create the problem or make it worse; and
- the results of any testing you've already done.

6.3 Shipping and Packaging

If you need to transport or ship your ServSwitch USB:

- Package it carefully. We recommend that you use the original container.
- If you are shipping the ServSwitch USB for repair, make sure you include its power supply. If you are returning the Switch, make sure you include everything you received with it. Before you ship, contact Black Box to get a Return Authorization (RA) number.

NOTES

NOTES



Customer Support Information:

FREE tech support 24 hours a day, 7 days a week: Call **724-746-5500** or fax **724-746-0746**.

Mailing address: **Black Box Corporation**, 1000 Park Dr., Lawrence, PA 15055-1018

World-Wide Web: www.blackbox.com • E-mail: info@blackbox.com

© Copyright 2001. Black Box Corporation. All rights reserved.